

IN

Dienstag, 20. Dezember 2016 17:31

Konstrukt(ion)

line clouds

3-2-d-2 express

Laser(sch)melze

Laser-Technologie

span(n)ende Nacharbeit

dj rotation

AM TROPF...

ICH PRODUZIERTE HOCH

**HALT**

# Konstrukt(ion)

Dienstag, 20. Dezember 2016 16:49



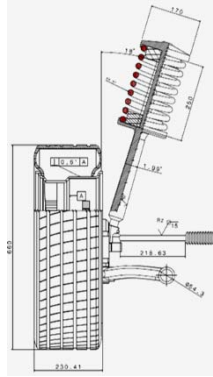

# line clouds

Dienstag, 20. Dezember 2016 15:31

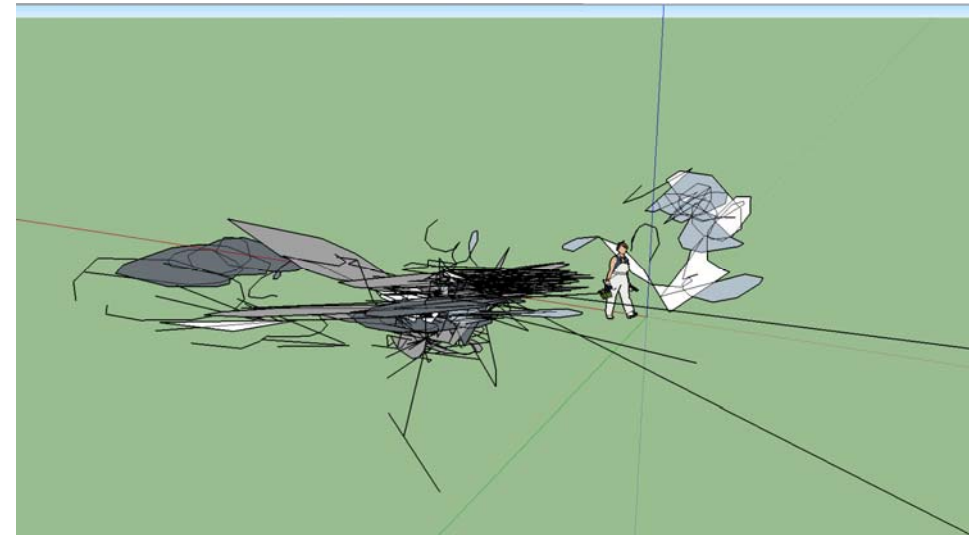
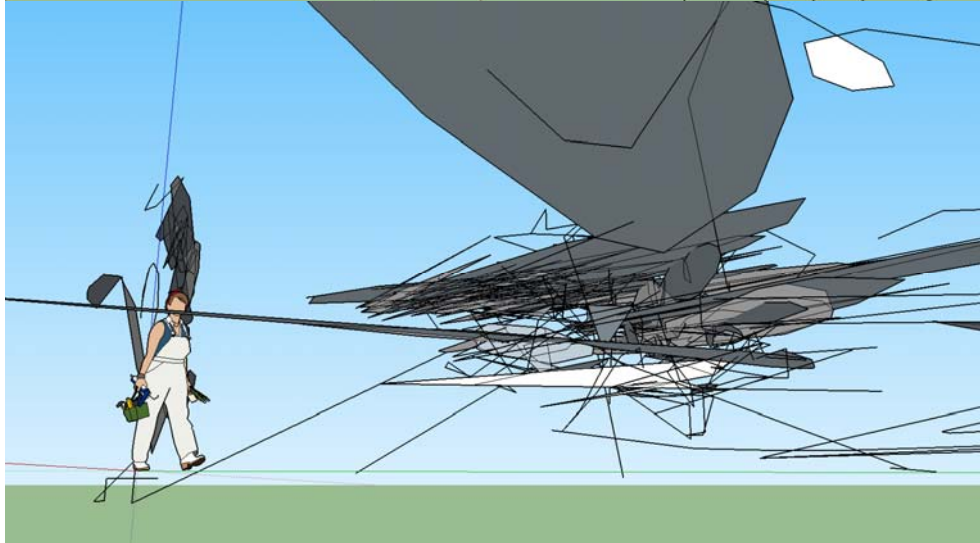
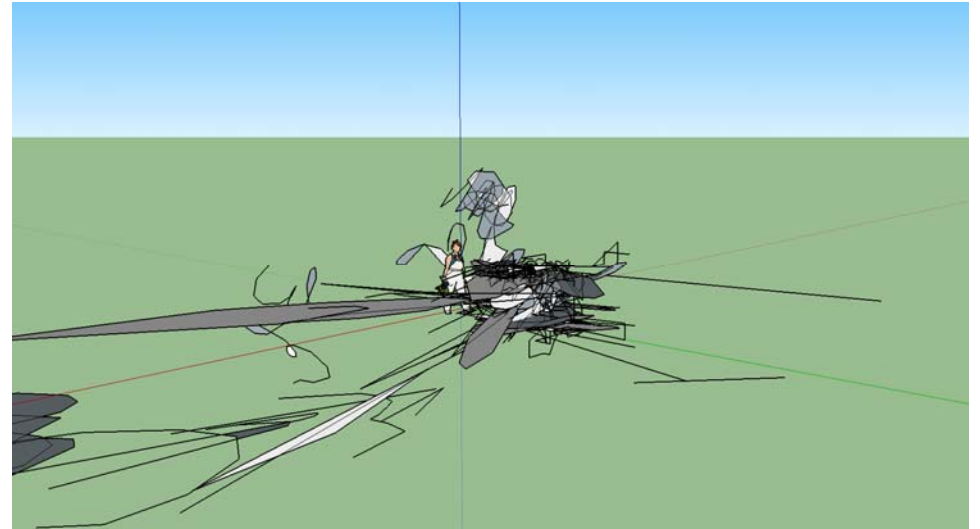
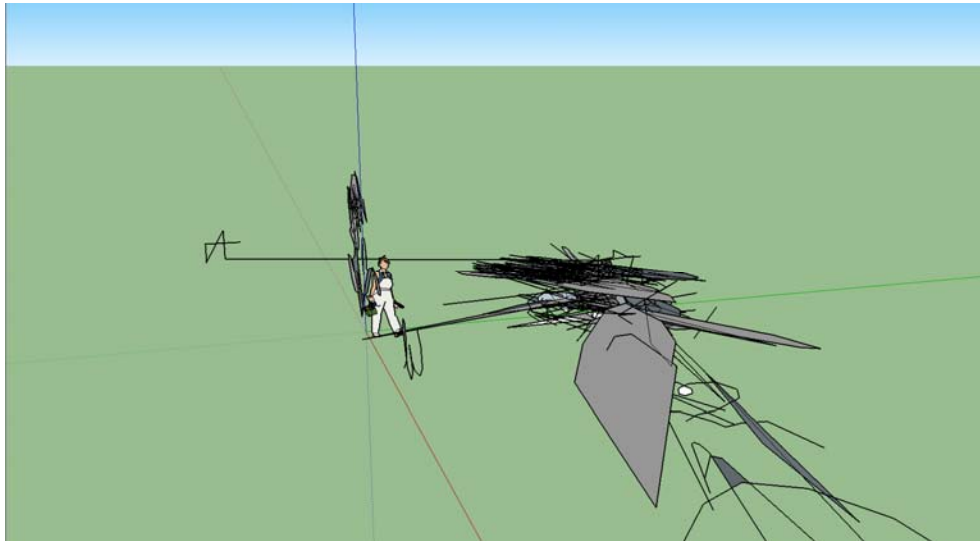

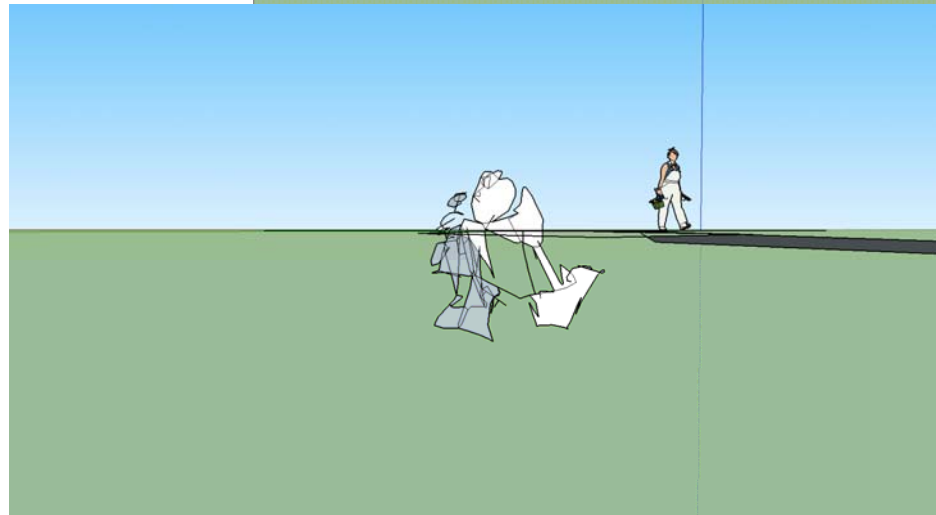
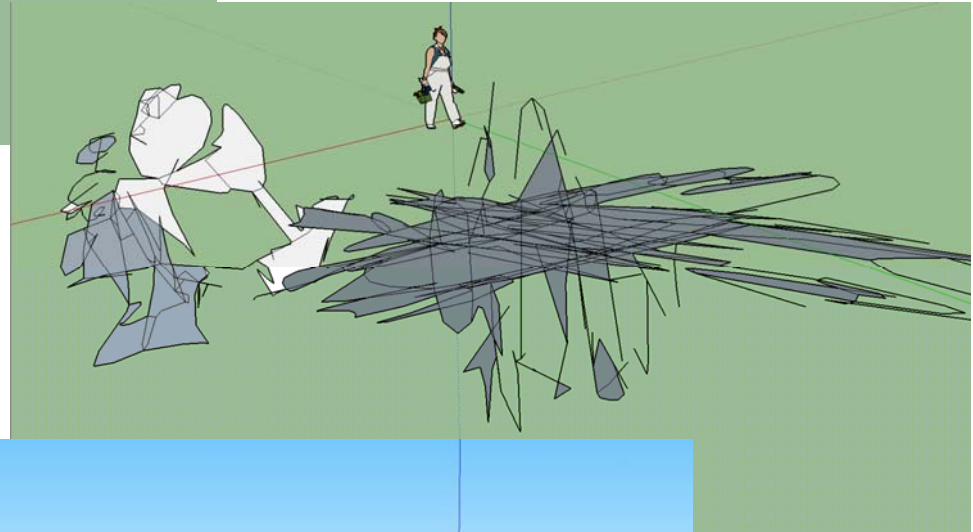
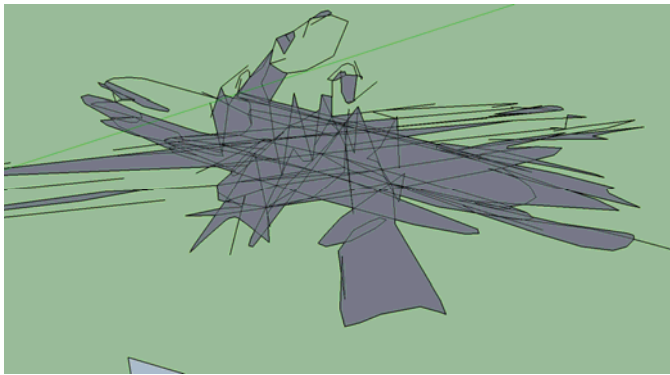
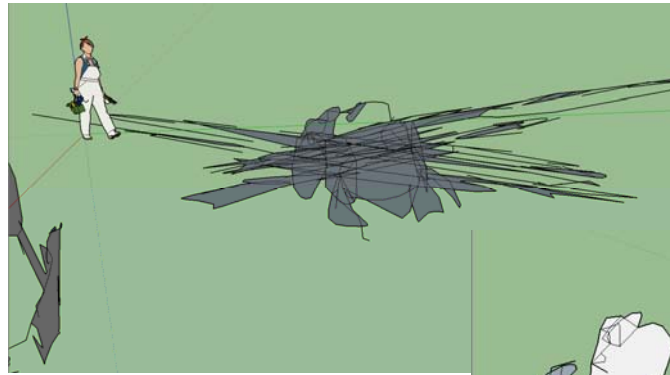
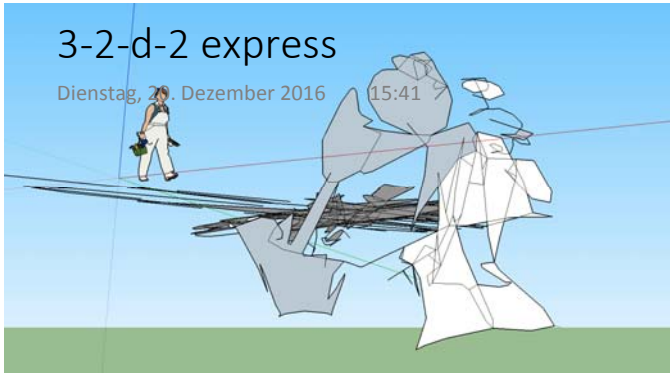

# Laser(sch)melze

Dienstag, 20. Dezember 2016 17:11



Selektives

Eine Technologie



**selektive  
Laserschmelze  
nicht an  
Richtlinien  
gebunden**

# span(n)ende Nacharbeit

Dienstag, 20. Dezember 2016 16:49

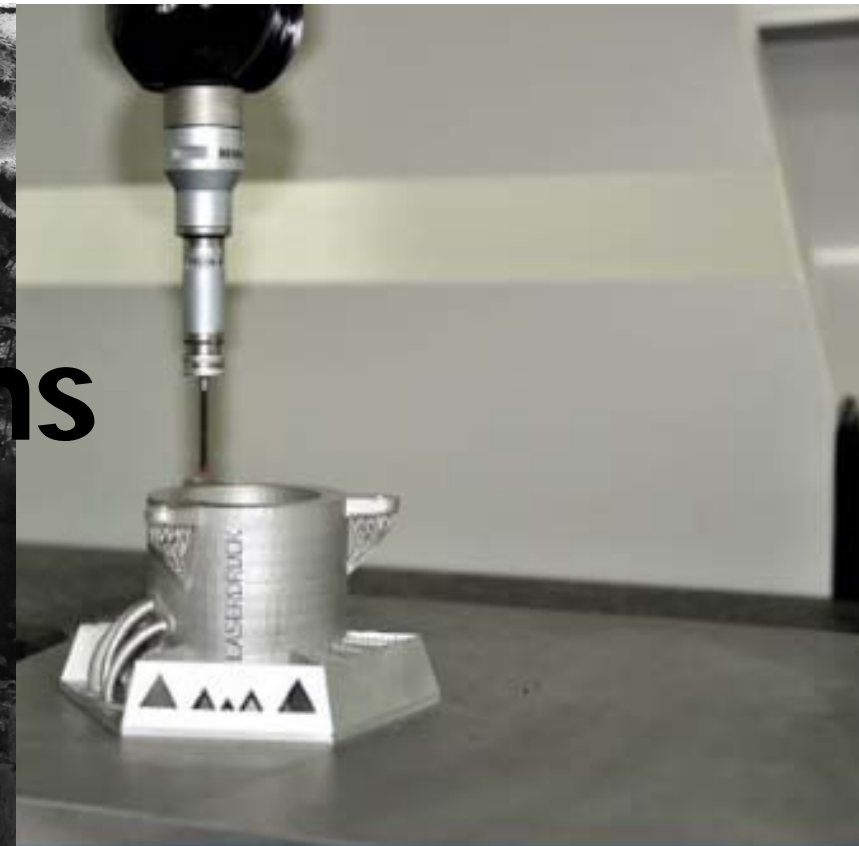



**dj rotation**

Dienstag, 20. Dezember 2016 16:50



punkformative Transformation

Freitag, 14. Oktober 2016 07:35

1 - ästhetische An-Ordnung  
 2 - Chaos  
 3 - Impuls  
 4 - Angst vor Verletzung  
 5 - die Farbe rot  
 6 - bis zu einem gewissen Punkt  
 7 - homöostatisches Handeln  
 8 - Blut

7 - Achtung, mein Kopf  
 8 - Was ist Rot und was ist Blau?  
 9 - In der weißen Rinde sägen  
 10 - ...  
 11 - ...  
 12 - kein ...  
 13 - dem Körper ...  
 14 - langes Schmelzen ...  
 15 - eine Nacht ...  
 16 - ...  
 17 - ...  
 18 - ...



**AM TROPF...**  
 am schlauch  
 am Draht  
 am Licht  
 baile dimensionale  
 3D-jabba-walk  
 Gruppe verdrahten  
 Kino im Garten  
 Parall-Universum  
 Tanz-Prozess-Maschine-Produkt

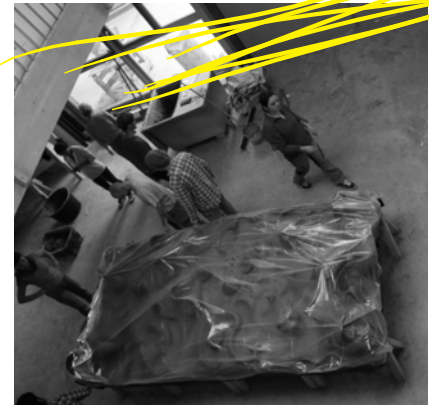

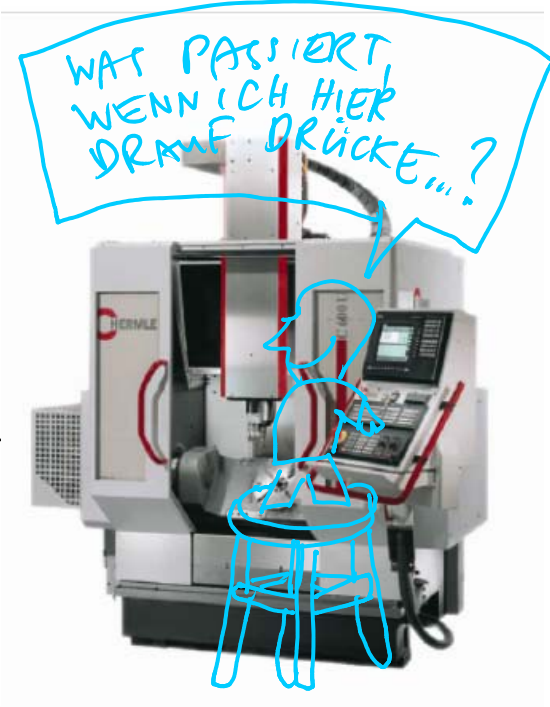
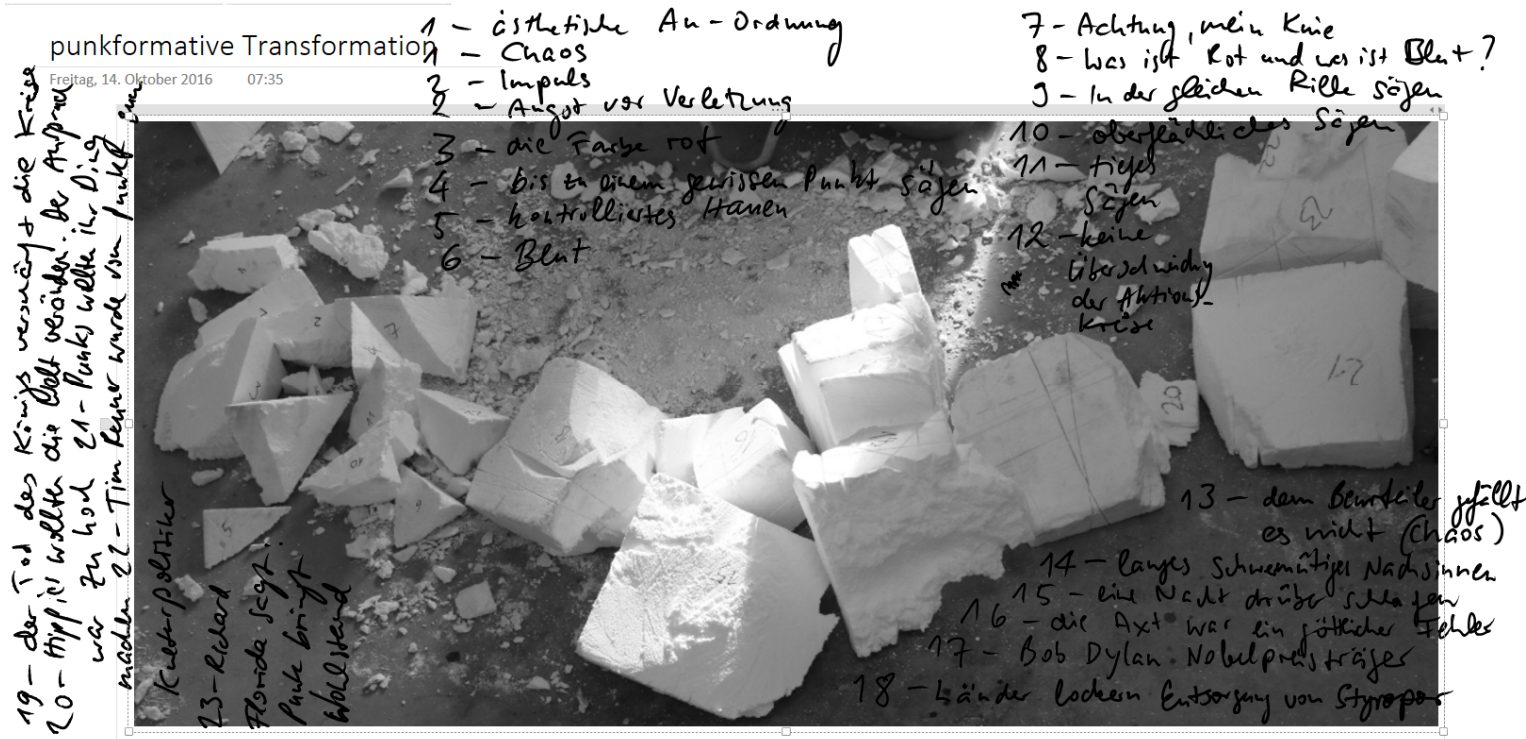

ICH PRODUZIERTE HOCHTECHNOLOGISCHE KUNST:  
 punkformative Transformation